

Smart Security - Simplified Management

accessIQ®

accessIQ®

PERSONALIZED ACCESS FOR SMALL COMMUNITIES



Managing mechanical keys is costly, with expenses reaching up to \$6,000* annually for a 50-unit building due to locksmith fees, lockouts, and key replacements. **accessIQ.** offers a smart, affordable solution designed to simplify property management, enhance security, and provide seamless access for tenants—all managed through your phone or computer.

*Based on a locksmith rate of \$200/hour and 30 hours of service annually.



A					

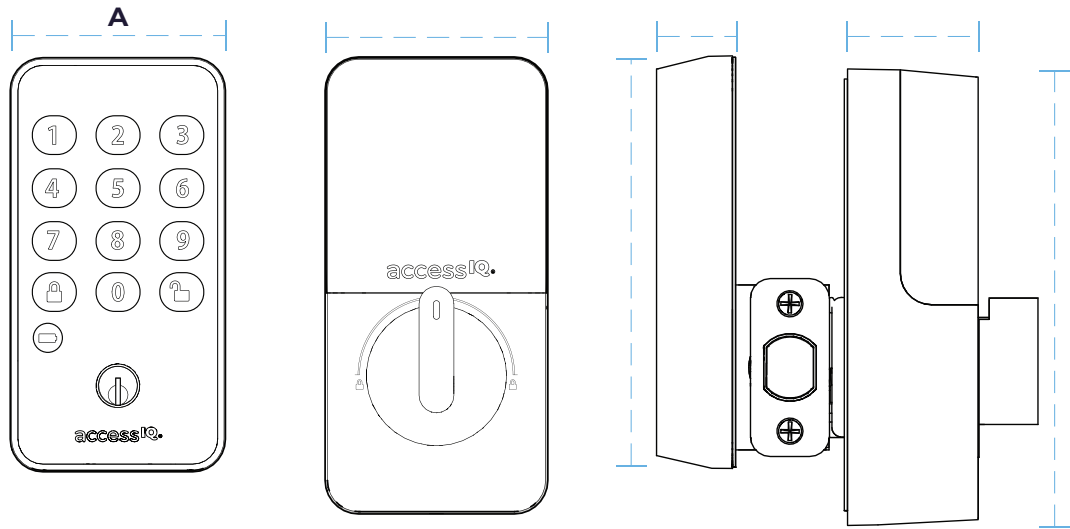

Door Prep:

Face Bore: 2-1/8 in. or 1-1/2 in., edge bore: 1 in.

Backset:

Adjustable for 2-3/8 in. or 2-3/4 in.

Door Thickness:

1-3/8 in. to 1-3/4 in.

Cylinder:

KW1

Faceplate:

2-1/4 in. Round corner, 2-1/4 in. square corner

Strikes:

2-3/4 in. Round corner, 2-3/4 in. square corner

Bolt:

1 in. Throw, steel, anti-saw pin

User Codes:

Up to 50 user codes

ANSI:

Meets ANSI Grade 2 standards

UL:

Fire rated 20 minutes

Battery:

Rechargeable 9,600mAh lithium-ion battery

Operating Temp:

-31°F to 151°F (-35°C to 66°C)



Exterior of lock

Interior height designed to accommodate a privacy latch/deadbolt

Finishes Available:



Satin Nickel

SKU: Q1001-619

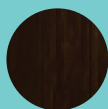

Oil Rubbed Bronze

SKU: Q1001-613



Matte Black

SKU: Q1001-622



KEY FEATURES



Keyless Entry: Say goodbye to fumbling for keys and late night lock-outs. With AccessIQ, tenants can access their apartment effortlessly using a smartphone, key card or PIN code.





Secure Mobile App: Our intuitive mobile app lets you; lock and unlock your door, see an activity log of lock access, check battery charge level and lock status, and grant access to family, friends and service providers. With the gateway this can all be done from anywhere in the world.



Virtual Keys: Share access with ease. Grant temporary or permanent virtual keys to visitors, housekeepers, maintenance staff, and more, ensuring secure and monitored entry.



Advanced Encryption: Rest easy knowing your data is safe. AccessIQ utilizes state-of-the-art encryption to safeguard your personal information and keep unauthorized access at bay.

- 1 Apple Wallet/Google Wallet  
- 2 Keycard
- 3 Pin code
- 4 Mobile app
- 5 Mechanical key



Auto-Lock: No more wondering if you locked the door. AccessIQ's auto-lock feature ensures your door is securely locked after a set and customizable period.



Real-Time Notifications: With the gateway, stay informed about your home's security. Receive instant notifications whenever someone enters or exits your apartment, ensuring you're always in the know.



Motorized latch: Motorized latch for convenience in auto-locking and remote operation.



Sleek Design: Designed to complement any décor, AccessIQ seamlessly blends functionality with style, enhancing the aesthetics of your living space.



Rechargeable Battery: AccessIQ's battery technology will last over a year on a single charge (up to 10 activations/day). Battery status for each lock is on the web portal, in the app and on the lock. It's easy to charge and you won't be throwing away costly disposable batteries.



Settings / Support

Indicates tenant apartment

eKey type

Connected (Gateway or Bluetooth)

Share eKey access

eKeys shared with others

Activity log

Community name

Add to Apple Wallet Button
(Disappears once added)

Siri shortcut
(Disappears once dismissed)

Battery Level

Lock status

Press to lock/unlock

More features:
Details
Rename
Settings
Accesscodes & cards
Delete eKey

TENANT
APARTMENT

Download the AccessIQ App





SMART SECURITY - SIMPLIFIED MANAGEMENT

Common area name

Schedule of access

Indicates common area

eKey type

Connected (Gateway or Bluetooth)

Share eKey access

eKeys shared with others

Expand card

Lock statuses

Battery Level

Lock status

Press to lock/unlock

More features:
Details
Rename
Delete eKey

Activity log



COMMON AREA

SPECIFICATIONS & DIMENSIONS

For the AccessIQ™ Gateway.



Specs

Power:	100-240V, 50/60Hz via AC Adapter (Included)
Power connection:	3' USB-C Cable (Included)
Connectivity:	Cellular LTE/5G, Bluetooth Low Energy (BLE)
Range:	Up to 300 feet (line of sight)
Security:	End-to-end advanced encryption
Device support:	Capable of connecting up to 8 smart locks
Installation:	Wall Mounted (hardware included)
Operating Temperature:	-10°C to 45°C (14°F to 113°F).

Dimensions

	Gateway (Q0101-GW)
A (in.)	4.7
B (in.)	4.7
C (in.)	1.8

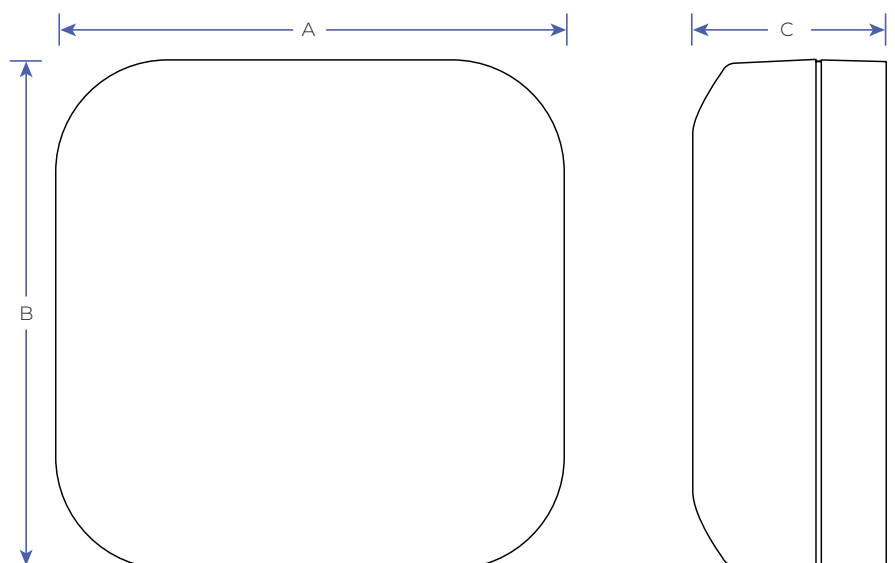

Indoor Locations

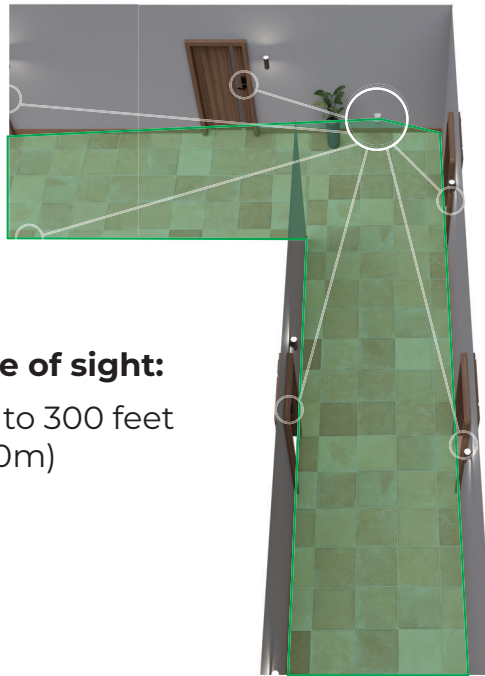
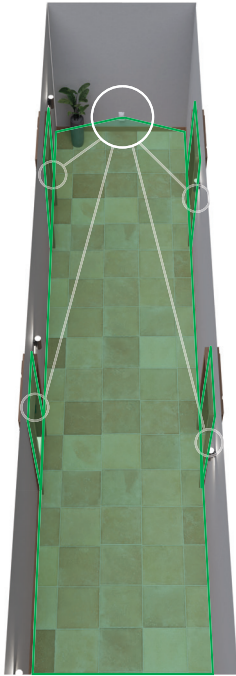

Line of sight:
Up to 300 feet
(100m)



1 Gateway supports
up to **8** Locks

Outdoor Locations



1 Gateway supports
up to **8** Locks

Line of sight:
Up to 300 feet
(100m)



SPECIFICATIONS & DIMENSIONS

For the AccessIQ™ Passage Levers.



Specs

Door Preparation:	Cross bore 2-1/8 in., edge bore 1 in., 1 in. x 2-1/4 in. latch mortise
Backset:	2-3/8 in. or 2-3/4 in.
Door Thickness:	1-3/8 in. to 1-3/4 in.
Chassis:	Tubular
Faceplate:	2-1/4 in. Round corner
Strike:	2-1/4 in. Full lip
Bolt:	1/2 in. Throw
UL Fire:	3 Hour fire rated
ADA:	ADA compliant
Door Handing:	Reversible for left or right handed doors
ANSI Grade:	Meets ANSI Grade 3 standards

Function

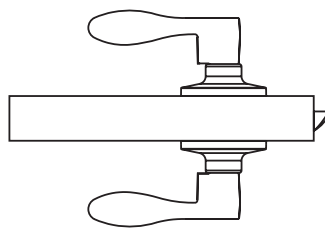

Passage
Non-locking



Aria
Satin Nickel



Wave
Oil Rubbed Bronze

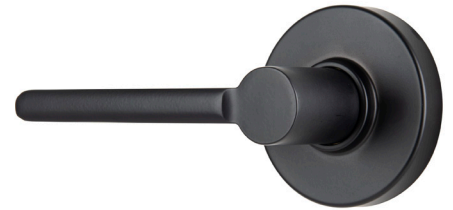

Axel
Matte Black

Style	Satin Nickel - 619	Oil Rubbed Bronze - 613	Matte Black - 622
Aria (Q1012)	●	●	●
Wave (Q1010)	●	●	●
Axel (Q1014)	●	●	●

Dimensions

Aria

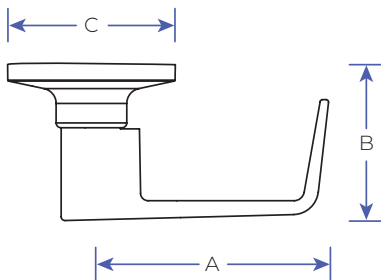

Wave

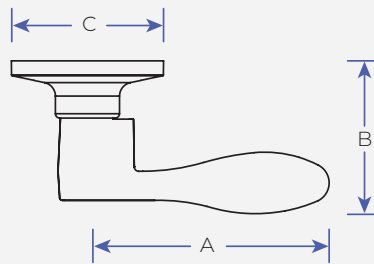

Axel

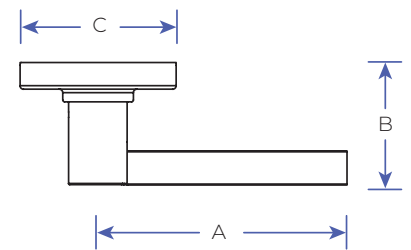

	A (in.)	B (in.)	C (in.)
Aria (Q1012)	4.1	2.4	2.6
Wave (Q1010)	4.6	2.4	2.4
Axel (Q1014)	4.2	2.2	2.4

Smart Security - Simplified Management

accessIQ®



aiq®

accessIQ.com
877 ENTRYIQ (877 368-7947)

85100-00012_REVB 12/24

